

Datasheet

DW01B

One Cell Lithium-ion/Polymer Battery Protection IC

FORTUNE,
Properties
For Reference Only

Fortune Semiconductor Corporation

富晶電子股份有限公司

28F, No. 27, Sec. 2, Zhongzheng E. Rd.,

Danshui Dist, New Taipei City 251, Taiwan

Tel. : 886-2-28094742

Fax : 886-2-28094874

www.ic-fortune.com

This manual contains new product information. **Fortune Semiconductor Corporation** reserves the rights to modify the product specification without further notice. No liability is assumed by **Fortune Semiconductor Corporation** as a result of the use of this product. No rights under any patent accompany the sale of the product.

1. General Description

The DW01B battery protection IC is designed to protect lithium-ion/polymer battery from damage or degrading the lifetime due to overcharge, overdischarge, and/or overcurrent for one-cell lithium-ion/polymer battery powered systems, such as cellular phones.

The ultra-small package and less required external components make it ideal to integrate the DW01B into the limited space of battery pack. The accurate $\pm 50\text{mV}$ overcharging detection voltage ensures safe and full utilization charging. The very low standby current drains little current from the cell while in storage.

2. Features

- Reduction in Board Size due to Miniature Package SOT-23-6.
- Ultra-Low Quiescent Current at $3\mu\text{A}$ ($V_{\text{CC}}=3.9\text{V}$).
- Ultra-Low Power-Down Current at $0.1\mu\text{A}$ ($V_{\text{CC}}=2.0\text{V}$).
- Precision Overcharge Protection Voltage $4.3\text{V} \pm 50\text{mV}$
- Load Detection Function during Overcharge Mode.
- Two Detection Levels for Overcurrent Protection.
- Delay times are generated by internal circuits. No external capacitors required.
- 0V-Battery charging function

3. Ordering Information

DW01B-G

PACKAGE TYPE

SOT-23-6(G stands for Green-Package)

TEMPERATURE RANGE

$-40^{\circ}\text{C}\sim+85^{\circ}\text{C}$

OVERCHARGE PROTECTION

$4.3\text{V} \pm 50\text{mV}$

4. Applications

- Protection IC for One-Cell Lithium-Ion / Lithium-Polymer Battery Pack

5. Product Name List

Model	Package	Overcharge detection voltage [VOCP] (V)	Overcharge release voltage [VOCR] (V)	Overdischarge detection voltage [VODP] (V)	Overdischarge release voltage [VODR] (V)	Overcurrent detection voltage [VOI1] (mV)
DW01B	SOT-23-6	4.30±0.050	4.100±0.050	2.40±0.100	3.0±0.100	150±30

6. Pin Configuration and Package Marking Information

Pin No.	Symbol	Description
1	OD	MOSFET gate connection pin for discharge control
2	CS	Input pin for current sense, charger detect
3	OC	MOSFET gate connection pin for charge control
4	TD	Test pin for reduce delay time
5	VCC	Power supply, through a resistor (R1)
6	GND	Ground pin

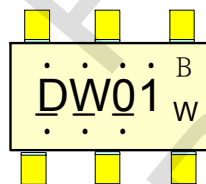
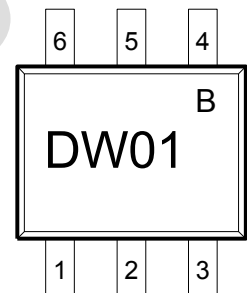

Top Point and Under_line : Lot No.
 Bottom Point : Year
 w : week, A~Z & A ~ Z

7. Functional Block Diagram

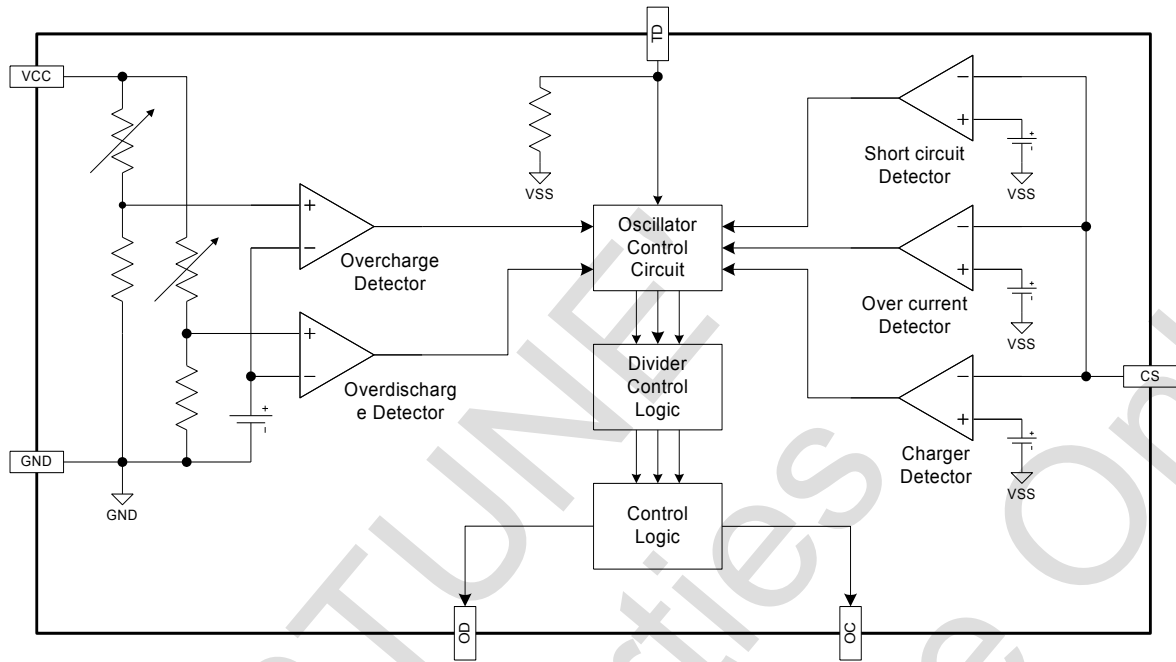

8. Typical Application Circuit

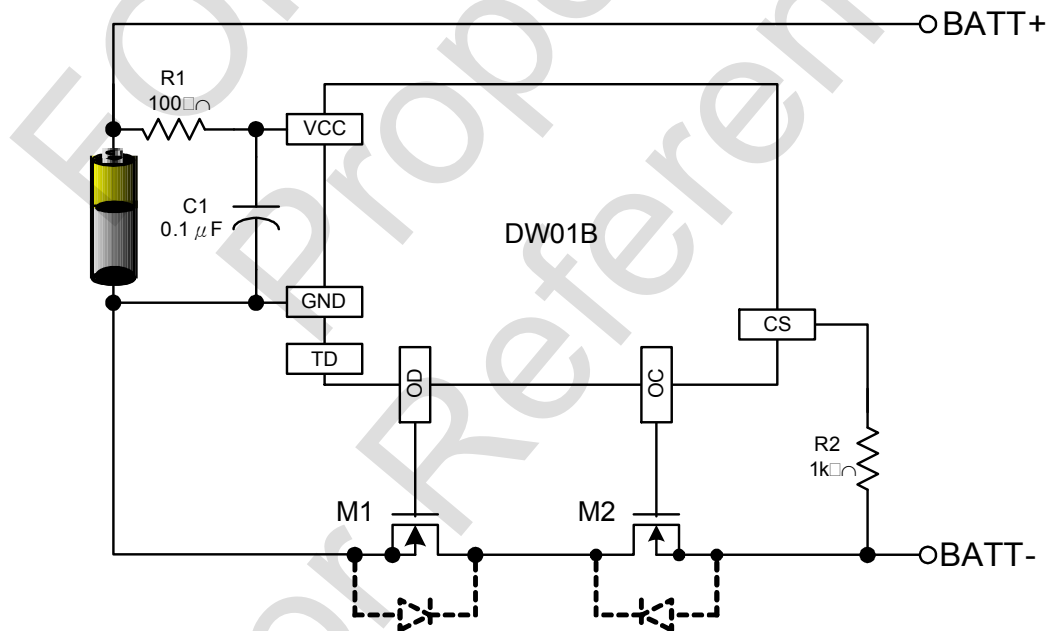

9. Absolute Maximum Ratings

(GND=0V, Ta=25 °C unless otherwise specified)

Item	Symbol	Rating	Unit
Input voltage between VCC and GND *	VCC	GND-0.3 to GND+10	V
OC output pin voltage	VOC	VCC -24 to VCC +0.3	V
OD output pin voltage	VOD	GND-0.3 to VCC +0.3	V
CS input pin voltage	VCS	VCC -24 to VCC +0.3	V
Operating Temperature Range	TOP	-40 to +85	°C
Storage Temperature Range	TST	-40 to +125	°C

Note: DW01B contains a circuit that will protect it from static discharge; but please take special care that no excessive static electricity or voltage which exceeds the limit of the protection circuit will be applied to it.

10. Electrical Characteristics

(Ta=25°C unless otherwise specified)

PARAMETER	TEST CONDITIONS	SYMBOL	Min	Typ	Max	UNIT
Supply Current	VCC=3.9V	ICC		3.0	6.0	μA
Power-Down Current	VCC=2.0V	IPD			0.1	μA
Overcharge Protection Voltage	DW01B	VOCP	4.250	4.30	4.350	V
Overcharge Release Voltage		VOCR	4.050	4.10	4.150	V
Overdischarge Protection Voltage		VODP	2.30	2.40	2.50	V
Overdischarge Release Voltage		VODR	2.90	3.00	3.10	V
Overcurrent Protection Voltage		VOIP (VOI1)	120	150	180	mV
Short Current Protection Voltage	VCC=3.6V	VSIP (VOI2)	1.00	1.35	1.70	V
Overcharge Delay Time		TOC		80	200	ms
Overdischarge Delay Time	VCC=3.6V to 2.0V	TOD		40	100	ms
Overcurrent Delay Time (1)	VCC=3.6V	TOI1		10	20	ms
Overcurrent Delay Time (2)	VCC=3.6V	TOI2		5	50	μs
Charger Detection Threshold Voltage		VCHA	-1.2	-0.7	-0.2	V
OD Pin Output "H" Voltage		VDH	VCC-0.1	VCC-0.02		V
OD Pin Output "L" Voltage		VDL		0.1	0.5	V
OC Pin Output "H" Voltage		VCH	VCC-0.1	VCC-0.02		V
OC Pin Output "L" Voltage		VCL		0.1	0.5	V
Minimum operating Voltage for 0V charging. *Note1	Voltage defined as VDD-CSI, VDD-VSS=0V	VST			1.5	

Note1: Specified for 0V battery charging function version

11. Description of Operation

Normal Condition

If $VODP < VCC < VOCP$ and $VCH < VCS < VOI1$, M1 and M2 are both turned on. The charging and discharging processes can be operated normally.

Overcharge Protection

When the voltage of the battery cell exceeds the overcharge protection voltage (VOCP) beyond the overcharge delay time (TOC) period, charging is inhibited by turning off of the charge control MOSFET. The overcharge condition is released in two cases:

The voltage of the battery cell becomes lower than the overcharge release voltage (VOCR) through self-discharge.

The voltage of the battery cell falls below the overcharge protection voltage (VOCP) and a load is connected.

When the battery voltage is above VOCP, the overcharge condition will not release even a load is connected to the pack.

Overdischarge Protection

When the voltage of the battery cell goes below the overdischarge protection voltage (VODP) beyond the overdischarge delay time (TOD) period, discharging is inhibited by turning off the discharge control MOSFET.

The default of overdischarge delay time is 10ms. Inhibition of discharging is immediately released when the voltage of the battery cell becomes higher than overdischarge release voltage (VODR) through charging.

Overcurrent Protection

In normal mode, the DW01B continuously monitors the discharge current by sensing the voltage of CS

pin. If the voltage of CS pin exceeds the overcurrent protection voltage (VOIP) beyond the overcurrent delay time (TOI1) period, the overcurrent protection circuit operates and discharging is inhibited by turning off the discharge control MOSFET. The overcurrent condition returns to the normal mode when the load is released or the impedance between BATT+ and BATT- is larger than 500kΩ. The DW01B provides two overcurrent detection levels (0.15V and 1.35V) with two overcurrent delay time (TOI1 and TOI2) corresponding to each overcurrent detection level.

Charge Detection after Overdischarge

When overdischarge occurs, the discharge control MOSFET turns off and discharging is inhibited. However, charging is still permitted through the parasitic diode of MOSFET. Once the charger is connected to the battery pack, the DW01B immediately turns on all the timing generation and detection circuitry. Charging progress is sensed if the voltage between CS and GND is below charge detection threshold voltage (VCH).

Power-Down after Overdischarge

When overdischarge occurs, the DW01B will enter into power-down mode, turning off all the timing generation and detection circuitry to reduce the quiescent current to 0.1 μA ($VCC=2.0V$). At the same time, the CS pin is pull-up to VCC through an internal resistor.

Note: When a battery is connected to DW01B for the first time, it may not enter the normal condition (dischargeable may not be enabled). In this case, short the CS and VSS pins or connect to a charger to restore to the normal condition.

12. Design Guide

Selection of External Control MOSFET

Because the overcurrent protection voltage is preset, the threshold current for overcurrent detection is determined by the turn-on resistance of the charge and discharge control MOSFETs. The turn-on resistance of the external control MOSFETs can be determined by the equation: $R_{ON} = V_{OIP} / (2 \times I_T)$ (I_T is the overcurrent threshold current). For example, if the overcurrent threshold current I_T is designed to be 3A, the turn-on resistance of the external control MOSFET must be 25mΩ. Be aware that turn-on resistance of the MOSFET changes with temperature variation due to heat dissipation. It changes with the voltage between gate and source as well. (Turn-on resistance of MOSFET increases as the voltage between gate and source decreases).

As the turn-on resistance of the external MOSFET changes, the design of the overcurrent threshold current changes accordingly.

Suppressing the Ripple and Disturbance from Charger

To suppress the ripple and disturbance from charger, connecting R1 and C1 to VCC is recommended.

Protection the CS pin

R2 is used for latch-up protection when charger is connected under overdischarge condition and overstress protection at reverse connecting of a charger.

13. Timing Diagram

Overcharge Condition → Load Discharging → Normal Condition

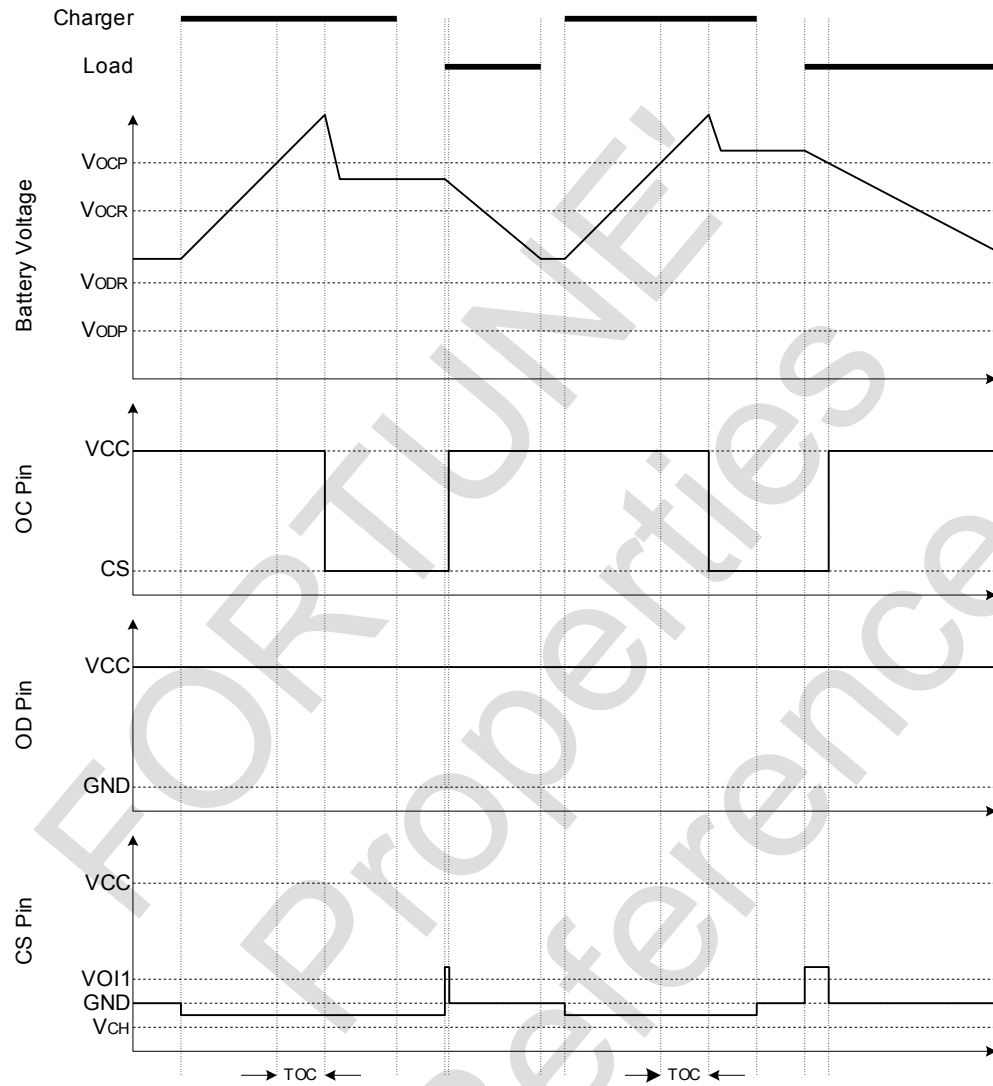

Overdischarge Condition → Charging by a Charger → Normal Condition

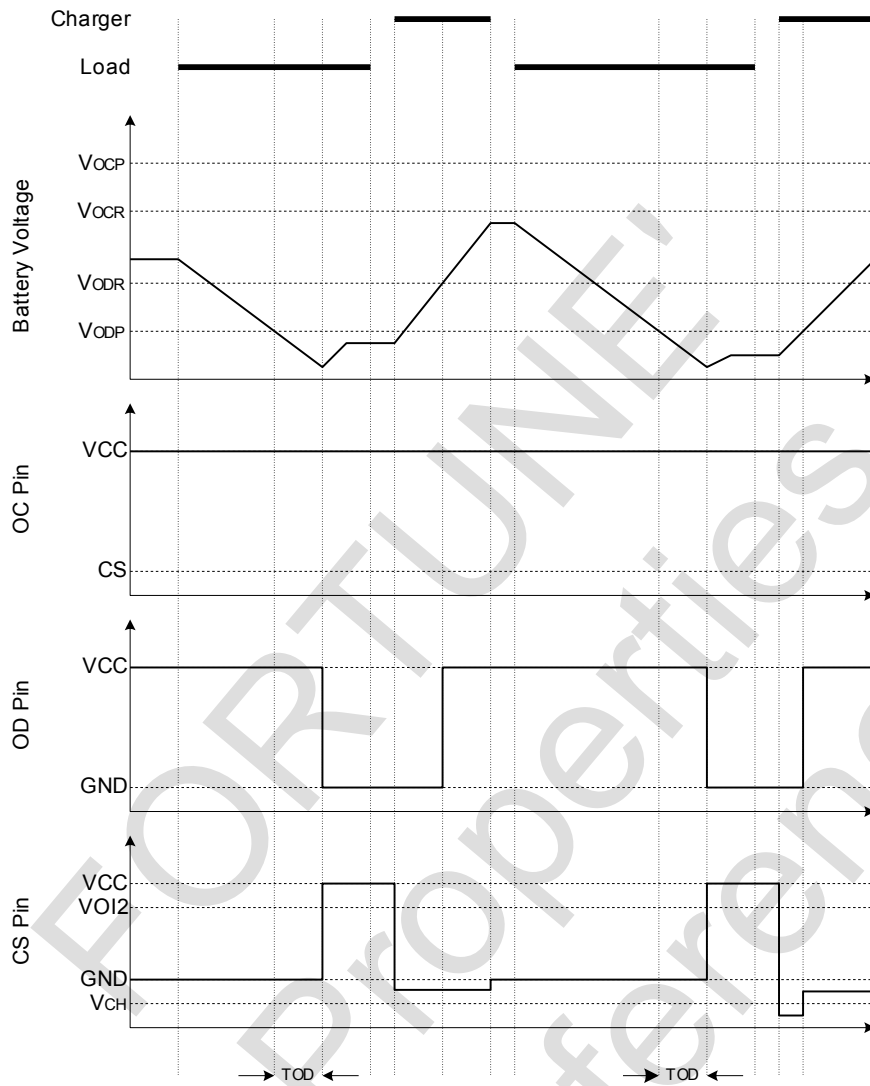

FOR FORTUNE'S Properties Only

Over Current Condition → Normal Condition

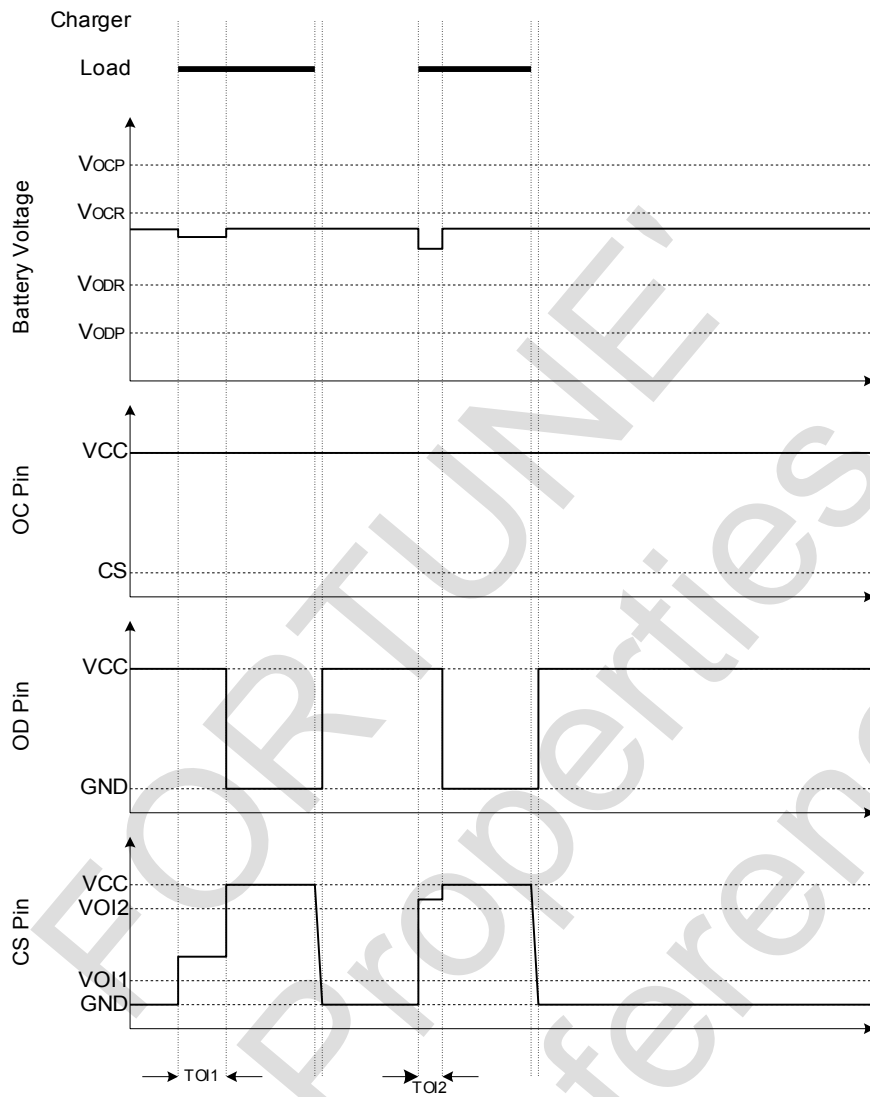

Characteristics(Typical Data)

Supply Current

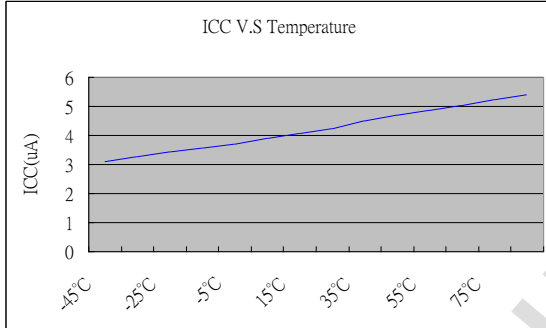

Power-Down Current

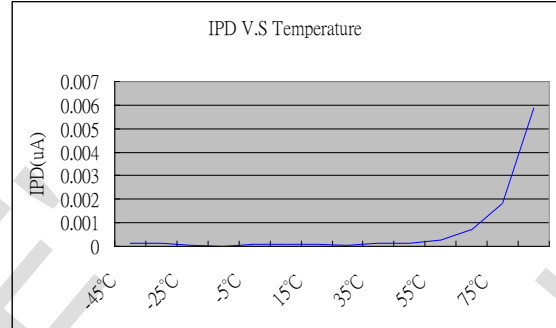

Overcharge Protection Voltage

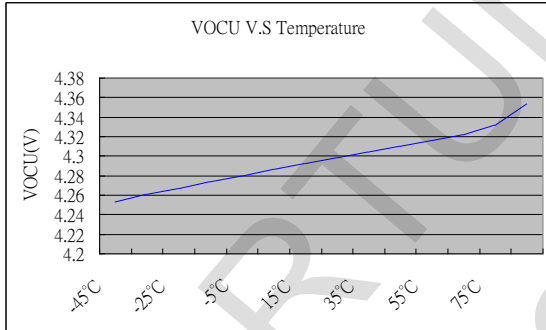

Overcharge Release Voltage

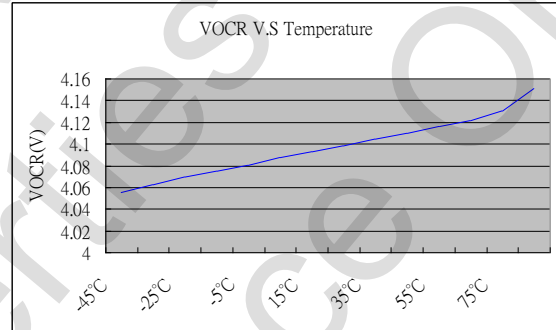

Overdischarge Protection Voltage

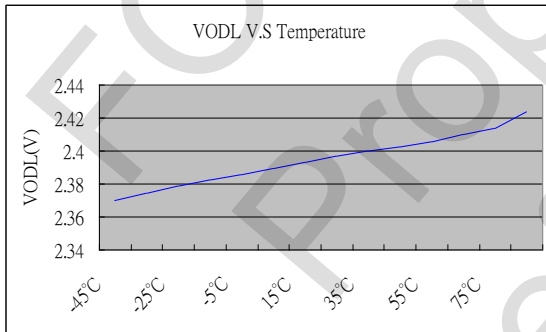

Overdischarge Release Voltage

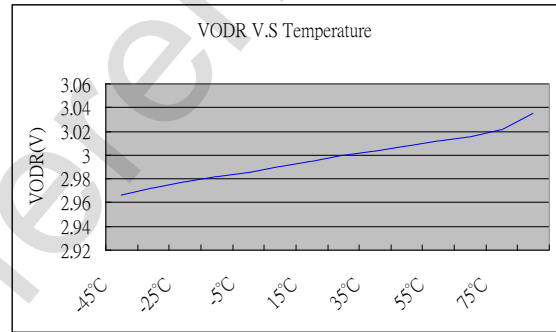

Overcurrent Protection Voltage

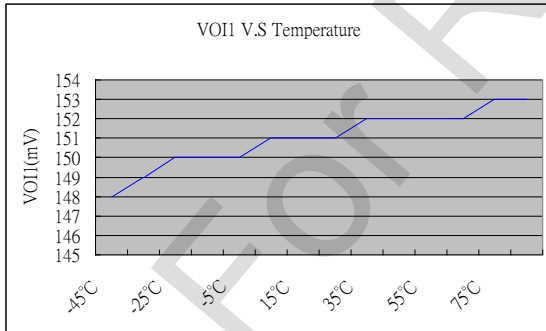

Shot Current Protection Voltage

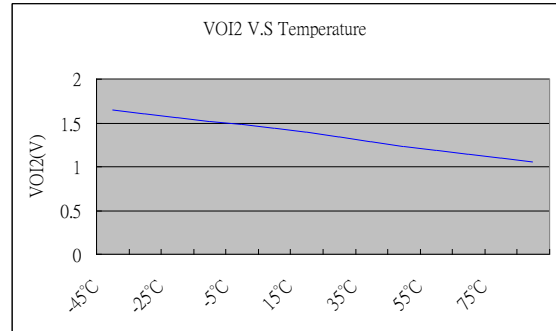

Overcharge Delay Time

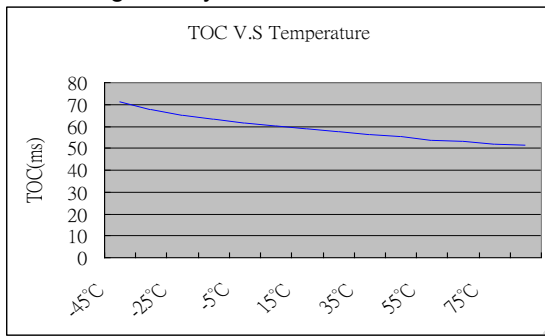

Overdischarge Delay Time

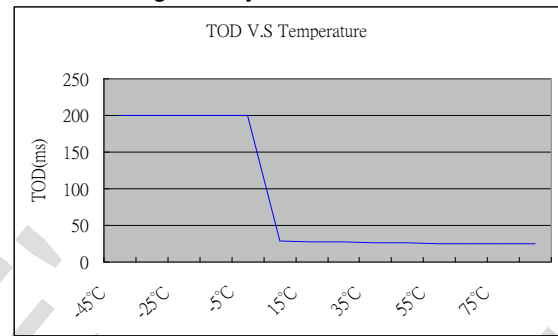

Overcurrent Delay Time(1)

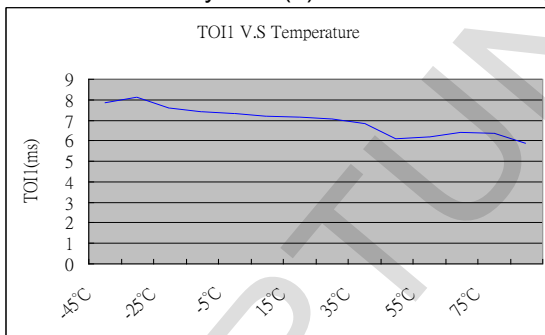

Overcurrent Delay Time(2)

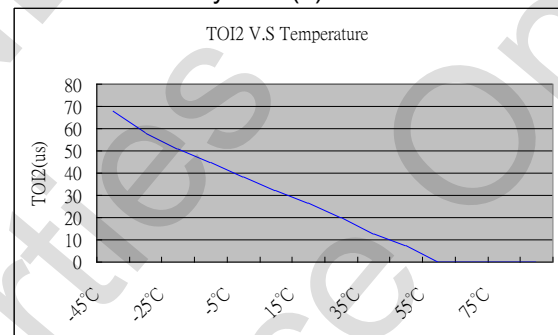

Charger Detection Threshold Voltage

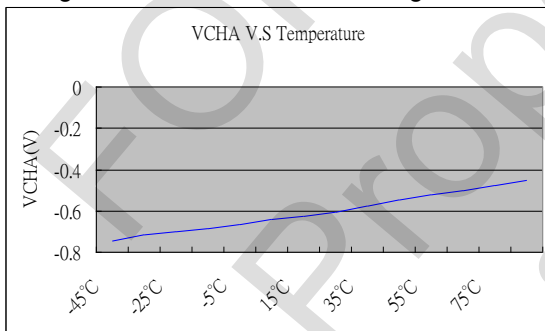

14. Package Outline

Dimension (SOT-23-6)

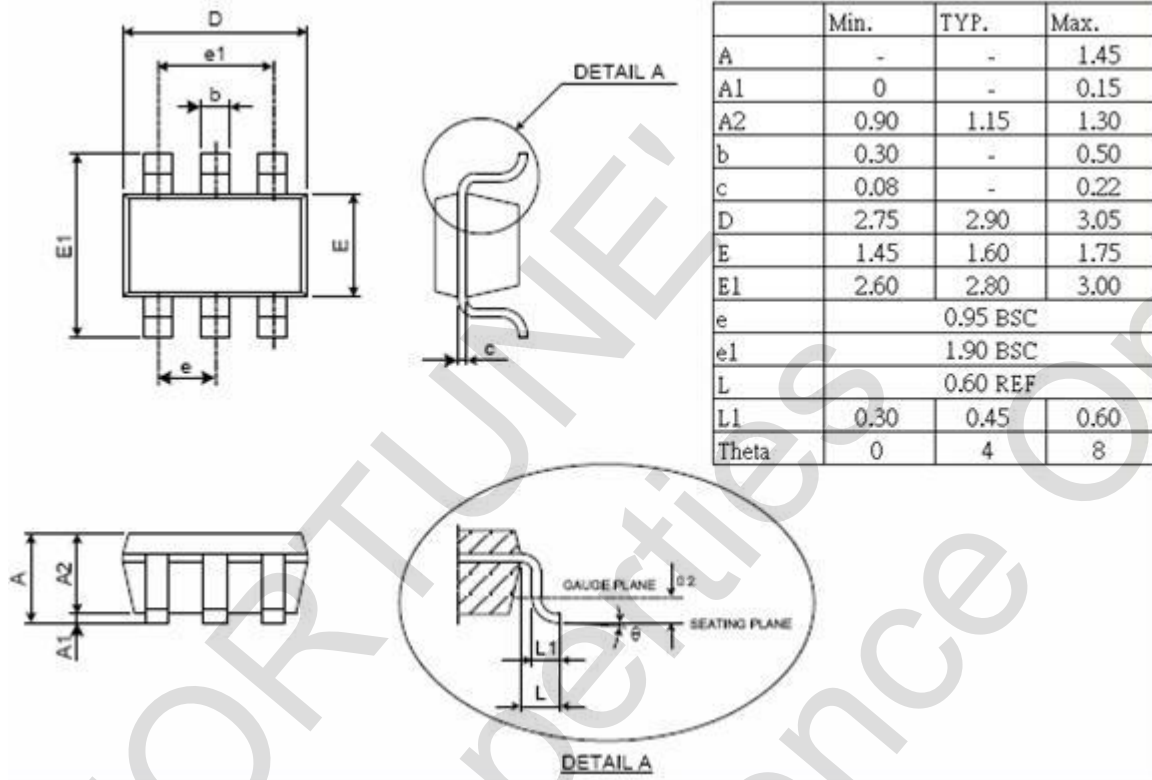

15. Revision History

Version	Date	Page	Description
1.0	2009/06/24	-	New release
1.1	2011/03/07	4	Revise VOCU : 4.3V±75mV , VO CR : 4.1V±75mV
1.2	2011/06/13	4	Revise VOCU : 4.3V±50mV , VO CR : 4.1V±50mV
1.3	2011/09/07	15	Revise Package Outline